

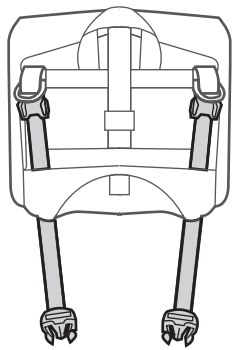

## AN ACCESSORY BAG USED OVER TOPEAK FRONTLOADER BAG SYSTEM



Verwendung als Zusatztasche auf dem Topeak FrontLoader Taschensystem.

Sac accessoire utilisé sur le système de sacs topeak frontloader

Bolsa Para Accesorios Adicionales Utilizada Sobre El Sistema Topeak Frontloader

Come borsello accessorio sopra la borsa Topeak FrontLoader.

Torba na akcesoria montowana na torbie topeak frontloader

トピーク フロントローダーへの取付方法

Topeak FrontLoader 시스템과 함께 장착이 가능합니다.

裝置在Topeak FrontLoader 上的附件袋

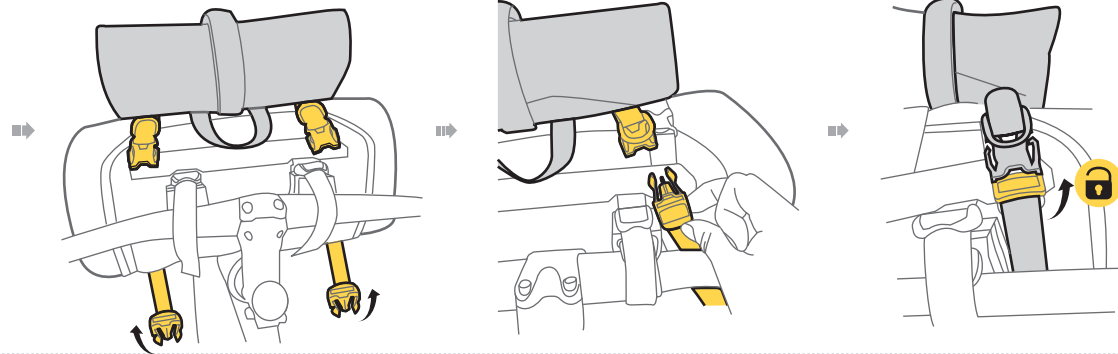

## INCLUDED SHOULDER STRAP FOR OFF-BIKE USE

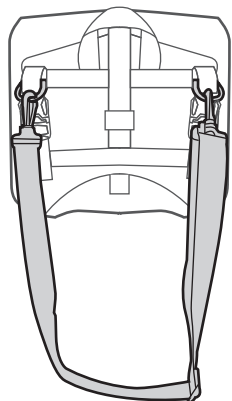

Inklusive Schultergurt für bequemen Transport abseits des Fahrrades

Sangle d'épaule incluse pour une utilisation hors vélo

Incluye Correa Para El Hombro

Tracolla inclusa per l'utilizzo senza bici

Dołączony pasek na ramię do użytku poza rowerem

付属のショルダーストラップの取付方法(自転車以外で使用する場合)

어깨끈을 자전거에 장착하는 용도로 사용하지 마십시오. 가방을 자전거에 장착하지 않고 사용할 경우 사용하십시오.

離開自行車時能夠肩背

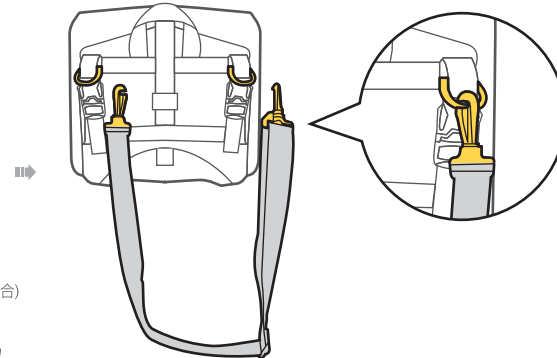



# BARLOADER

PREPARE TO RIDE

EN D F E I PL J KR CH

## INSTALLATION / MONTAGE / INSTALLTION / INSTALCIÓN 장착방법 / 取付方法



**A** Main waterproof bag  
Wasserdichte Haupttasche  
Sac étanche principal  
Bolsa principal impermeable  
Borsa impermeabile principale  
Główna wodoodporna torba  
防水バッグ  
방수기능을 지원하는 메인가방  
防水袋

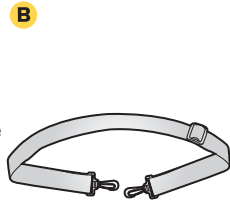

**B** Shoulder Strap  
Schultergurt  
Sangle d'épaule  
Correa para el hombro  
Shoulder Strap  
Pasek na ramię  
ショルダーストラップ  
어깨끈  
肩背帶



**C** Mounting Straps x 2pcs  
2x Befestigungsstraps  
Sangles de montage X2  
Correa para montaje X 2 Pcs  
Cinturini di montaggio x 2pz  
Paski montażowe X2  
스트랩 x 2  
짧은 스트랩 X 2개  
束帶 X 2pcs



**D** Mounting Strap  
Befestigungsstrap  
Sangle de montage  
Correa para montaje  
Cinturini di montaggio  
Paski montażowe  
스트랩  
긴 스트랩  
束帶

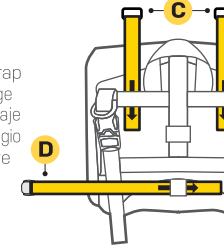

Mounting Strap  
Befestigungsstraps  
Sangles de montage  
Correa para montaje  
Cinturino di montaggio  
Paski montażowe  
스트랩  
스트랩 장착 방법  
束帶

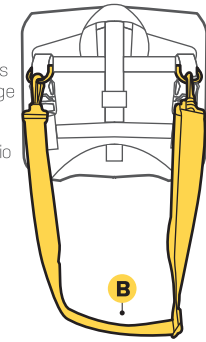

Shoulder Strap  
Schultergurt  
Sangle d'épaule  
Correa para el hombro  
Tracolla  
Pasek na ramię  
ショルダーストラップ  
어깨끈 장착 방법  
肩背帶

## MAIN WATERPROOF BAG

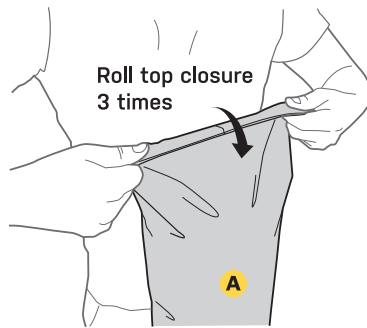

Roll top closure  
3 times

Rollverschluss  
mind. 3 mal rollen  
Fermeture à  
enroulement 3 fois  
Plegar los  
laterales hasta 3  
veces para cerrar  
Zroluj boczne  
zamknięcie 3 razy  
Girare 3 volte per  
chiudere  
Zamknijcie  
zwijane 3 razy  
ロールトップクロー  
ザーを3回以上巻  
いてください  
3회 정도 말아서  
입구를 닫아주십시오.  
將封口向内捲3次

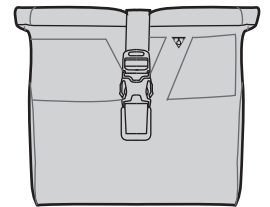
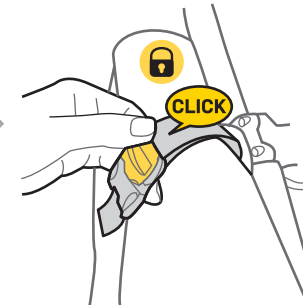
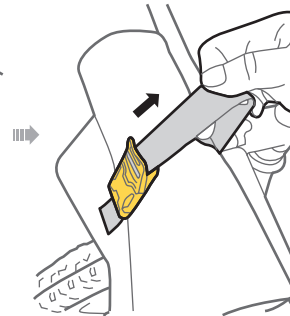
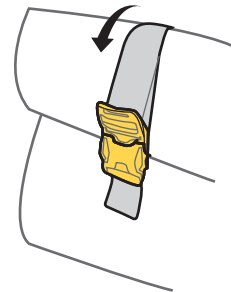
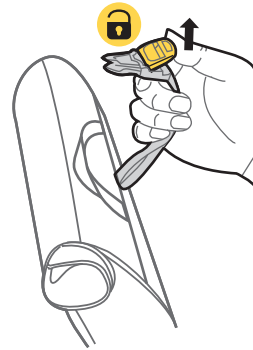

## MOUNT ON HANDLEBAR

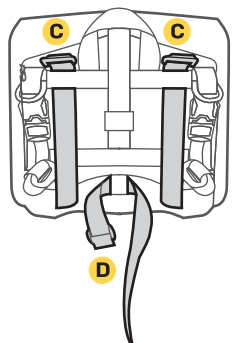

Verwendung  
ohne Topeak  
FrontLoader  
Taschensystem  
Montage sur  
guidon  
Montaje En El  
Manillar  
Utilizzare  
da solo  
Montaż na  
kierownicy  
バッグ単体での  
取付方法  
BARLOADER bag  
만 장착할 경우  
不使用Topeak  
FrontLoader  
情況下使用。

